



TRANE®

BAYSTAT253A Humidity Control

INSTALLER'S GUIDE

APPLICATION

The humidity control provides automatic low voltage control of humidifiers in central heating and cooling equipment for both humidification and dehumidification applications. See Fig. 1. It has an spst, snap-acting, dust-proof switch that opens when humidity rises above the control setting. It is designed for wall or surface duct mounting.

INSTALLATION

When Installing this Product...

1. Read these instructions carefully. Failure to follow them could damage the product or cause a hazardous condition.
2. Check the ratings given in the instructions and on the product to make sure the product is suitable for your application.
3. Installer must be a trained, experienced service technician.
4. After installation is complete, check out product operation as provided in these instructions.

CAUTION

Personal Injury Hazard.
Power supply can cause electrical shock.
Disconnect power supply before beginning installation.

Location and Mounting

A mounting template is included for mounting the humidity control next to your thermostat. See Fig. 2. However, the humidity control can be mounted in any other convenient location in the living area or equipment room.

NOTE: The humidity control electrical connections are not shared with the thermostat.

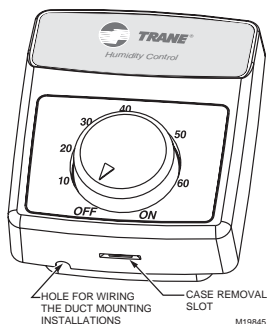

Fig. 1. Humidity control.

Wall Mounting

IMPORTANT

Mount the control in an area with average room temperature and average relative humidity.

Select a location for mounting the humidity control:

1. Hold the mounting template (included) next to your thermostat. Select the mounting side for the humidity control. The template is reversible for mounting on either the left or right side of the humidity control. See Fig. 2.
2. Mark the holes for the two mounting screws (included). Then mark the hole for the low voltage wiring on the template that corresponds with the side selected in step 1.
3. Remove the template and drill the holes.
4. Run low voltage wiring to the location and pull about 6 in. (152 mm) of wire through the hole.
5. Plug hole with nonflammable insulation to prevent drafts from affecting the control operation.
6. Remove the humidity control case from the base. See Fig. 1.
7. Position the base on the wall with the arrow up.
8. Use the two in. (25 mm) mounting screws to secure the base to the wall.

Pub. No.: 22-5203-01



69-1698

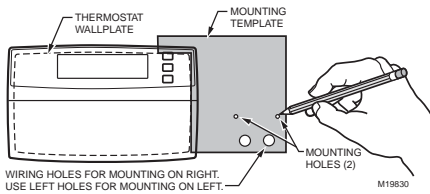

Fig. 2. Positioning mounting template.

IMPORTANT

Use 18- to 22-gauge wire for proper wiring.

9. Connect the low voltage wires to the leads on the humidity control.
10. Replace the humidity control case.

Duct Mounting

IMPORTANT

When mounting near an elbow area, locate the control 6 in. (152 mm) upstream from the elbow so the element is exposed to the normal airflow (Fig. 3).

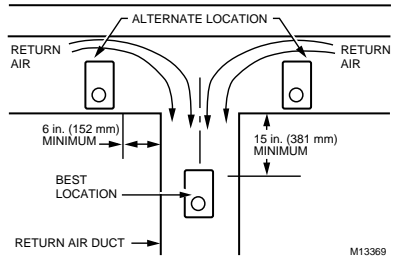

Fig. 3. Selecting duct location for control.

1. Locate the control at least 8 in. (203 mm) upstream from the humidifier in the return air duct. See Fig. 3.
2. Apply the duct template to the duct location.
3. Use the duct template, Fig. 4, to make the opening and mounting holes for the humidity control.
4. Remove the humidity control case from the base. See Fig. 1.
5. Position the foam gasket on the humidity control base.
6. Position the base on the duct with the arrow up.
7. Use the four 1 in. (25 mm) mounting screws to secure the base to the duct.
8. Connect the low voltage wires to the leads on the humidity control.
9. Replace the humidity control case.

IMPORTANT

Use 18- to 22-gauge wire for correct wiring.



Fig. 4. Positioning return air duct template.

HEATING CYCLE HUMIDITY CONTROL WIRING

CAUTION

Personal Injury Hazard.
Power supply can cause electrical shock and injury.
 Disconnect power supply before installation or servicing.

All wiring must comply with applicable local codes, ordinances and regulations. Make wiring connections according to humidifier instructions, if available; otherwise, see typical wiring diagrams in Fig. 5 through 9.

IMPORTANT

Select models of fan centers include humidifier taps so the current sensing relay or sail switch is not needed.

If not using a current sensing relay or sail switch, the humidifier must be energized during blower motor cycles for correct operation.

On multispeed blower applications, do not wire the high voltage side of the transformer to the same power source that services the furnace blower. Premature transformer burnout can occur.

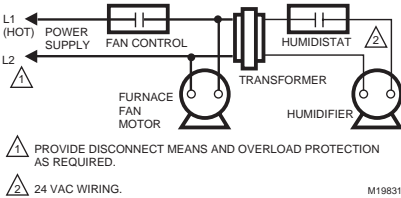

Fig. 5. Typical wiring diagram for system with fan interlock.

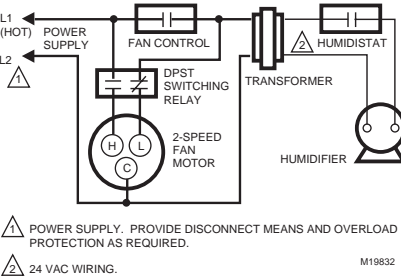

Fig. 6. Typical wiring diagram for system with 2-speed fan motor.

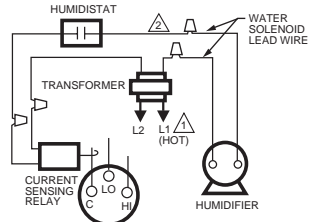

Fig. 7. Typical wiring diagram of current sensing relay with humidifier.

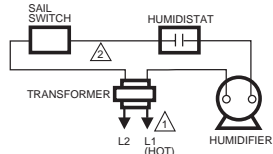

Fig. 8. Typical wiring diagram of sail switch with humidifier.

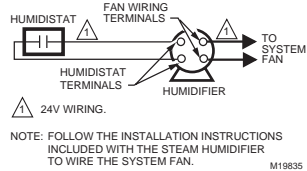

Fig. 9. Typical wiring diagram for steam humidifiers.

HEATING CYCLE HUMIDITY CONTROL ADJUSTMENTS

Humidity Control Adjustment

To maintain optimum humidity control without causing condensation on cold surfaces such as windows, the homeowner must adjust the setpoint as the outdoor temperature changes.

To reduce relative humidity, reduce the setpoint approximately 3% RH humidity every 24 hours. To increase relative humidity, increase the setpoint approximately 3% RH every 24 hours.

Setpoint Adjustment

Set the humidity setpoint according to the prevailing outdoor temperature. See Table 1 for recommended settings.

Table 1. Recommended Humidity Control Setting.

Outdoor Temperature		Recommended Humidity Control Setting
°F	°C	
-20	-29	15
-10	-23	20
0	-18	25
+10	-12	30
+20	-7	35
>+20	>-7	40

COOLING CYCLE HUMIDITY CONTROL WIRING



CAUTION

Personal Injury Hazard.
Power supply can cause electrical shock and injury.
 Disconnect power supply before installation or servicing.

All wiring must comply with applicable local codes, ordinances and regulations. Make wiring connections according to humidifier instructions, if available; otherwise, see typical wiring diagrams in Fig. 10 and 11.

COOLING CYCLE HUMIDITY CONTROL ADJUSTMENTS

It is desirable to maintain the humidity in the living space at the humidification comfort range of 25 to 50 percent relative humidity.

To reduce the relative humidity, position the arrow on the humidity control to the humidity control setting: 40 setting controls to 40+/-10% RH. 50 setting controls to 50+/-10% RH.

When activated, the humidity control lowers the furnace/air handler blower speed, reducing air velocity over the furnace/air handler coil and removing a greater amount of moisture from the air.

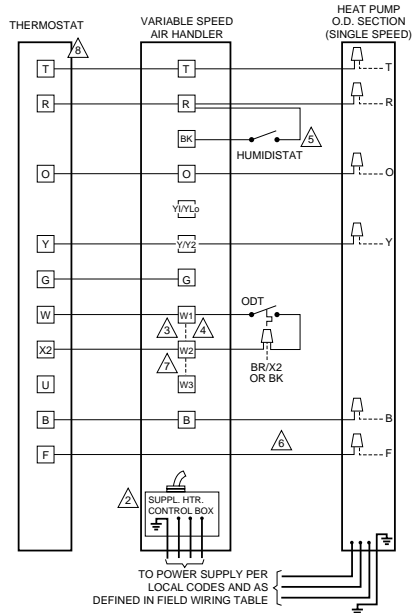

INTER-COMPONENT WIRING

--- 24 V LINE V } FACTORY WIRING --- 24 V LINE V } FIELD WIRING

- ⚠ 1. LOW VOLTAGE WIRING TO BE NO. 18 A.W.G. MINIMUM CONDUCTOR.
- ⚠ 2. WHEN HEATERS ARE USED, DISCARD POWER LEADS WITH POLARIZED PLUG PM-A AND CONNECT 1-PF TO MATING PLUG IN THE HEATER CONTROL BOX AS SHOWN.
- ⚠ 3. TERMINALS W2 WILL HAVE INTERNAL CONNECTIONS ONLY IF 2ND CONTACTOR IS USED BY THE HEATER FOR CONTROLLING POWER TO ELECTRIC HEATING ELEMENTS. IF 2ND (BH) CONTACTOR IS NOT USED, THEN FIELD CONNECTIONS TO W2 CAN BE OMITTED AS APPROPRIATE.
- ⚠ 4. IF ODT IS NOT USED, THEN CONNECT APPROPRIATE JUMPER FROM W1 TO W2 TO W3 ON LVTB.
- ⚠ 5. IF HUMIDISTAT IS NOT USED, CONNECT JUMPER FROM "R" TO "BK" FOR FULL TONNAGE AIRFLOW IN COOLING.
- ⚠ 6. CONNECT IN THIS MANNER IF O.D. UNIT HAS "F" CONNECTION.
- ⚠ 7. CONNECT W3 TO W2 ONLY IF USING HEATER WITH 3 HEATER STAGES.
- ⚠ 8. SEE HEATER WIRING DIAGRAM FOR HEATING ANTICIPATOR SETTING.

M19852

Fig. 10. Wiring for variable-speed air handler.

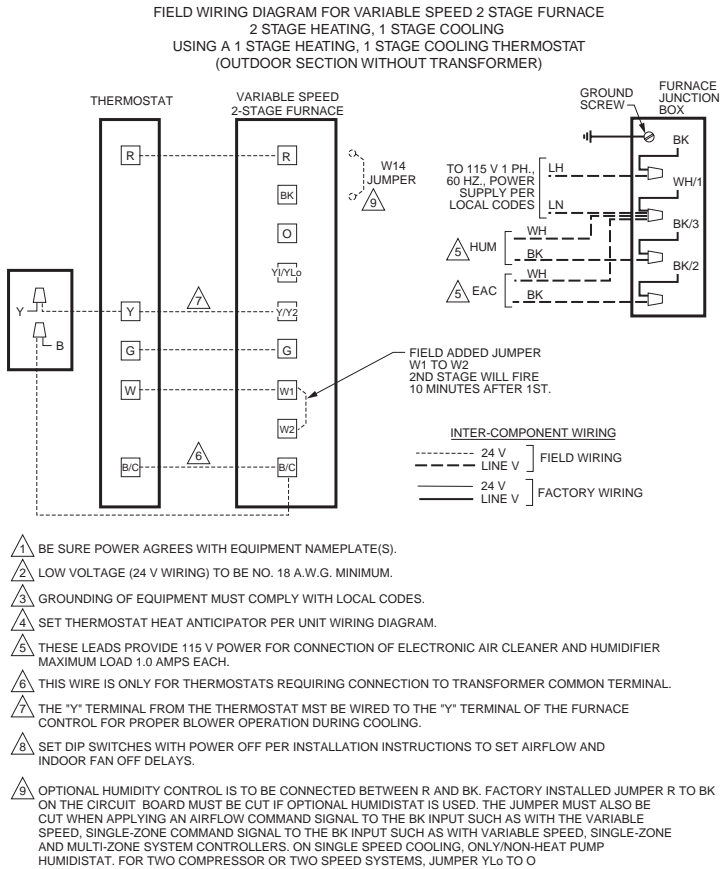

M19853

Fig. 11. Wiring for variable-speed, 2-stage furnace (2H/1C) using 1H/1C thermostat.

OPERATION AND CHECKOUT

Place the system in operation and observe through at least one complete cycle to make certain that all components are functioning correctly.

